

**END
FILMED**

DATE:

2-91

DTIC

INITIAL DISTRIBUTION

- 4 Naval Air Systems Command
 - AIR-5004 (2)
 - AIR-505 (2)
- 1 Chief of Naval Research (Technical Library)
- 2 Naval Sea Systems Command (SEA-098312)
- 1 Commander in Chief, U. S. Pacific Fleet, Pearl Harbor (Code 325)
- 1 Commander, Third Fleet, San Francisco
- 1 Commander, Seventh Fleet, San Francisco
- 2 Naval Academy, Annapolis (Director of Research)
- 1 Naval Air Development Center, Warminster (Technical Library)
- 1 Naval Avionics Center, Indianapolis (Technical Library)
- 1 Naval Ocean Systems Center, San Diego
- 1 Naval Ordnance Station, Indian Head (Technical Library)
- 1 Naval Postgraduate School, Monterey
- 1 Naval Research Laboratory (Technical Library)
- 1 Naval Strike Warfare, Fallon (Intelligence Library)
- 4 Naval Surface Weapons Center, Dahlgren
 - Technical Library (1)
- 3 Naval Surface Weapons Center, White Oak Laboratory, Silver Spring
 - Technical Library (1)
- 1 Naval War College, Newport
- 1 Naval Weapons Support Center, Crane (Technical Library)
- 7 Pacific Missile Test Center, Point Mugu
 - Technical Library (1)
- 1 Aberdeen Proving Ground (Technical Library)
- 1 Army Armament Research, Development and Engineering Center, Dover (Technical Library)
- 1 Harry Diamond Laboratories, Adelphi (Technical Library)
- 1 Headquarters, U. S. Air Force (Deputy Chief of Staff, Research and Development)
- 1 Air Force Armament Division, Eglin Air Force Base (Technical Library)
- 3 Air Force Acquisition Logistics Division, Wright-Patterson Air Force Base
 - AFAL/AFSC (1)
- 1 Air Force Intelligence Agency, Bolling Air Force Base (AFIA/INTAW, Maj. R. Egan)
- 12 Defense Technical Information Center, Alexandria
- 3 Aerospace Corporation, Los Angeles, CA
 - C. Manning (1)
 - S. Rubin (1)
 - C. Tanner (1)
- 25 Astron Research and Engineering, Santa Monica, CA (A. G. Pierson)
- 1 Bird Engineering Research Associates, Incorporated, Vienna, VA
- 1 General Dynamics Corporation, Convair Division, San Diego, CA (H. Reid)
- 4 General Dynamics Corporation, Pomona Division, Pomona, CA
 - D. Underhill (1)
- Technical Library (1)
- 1 Hudson Institute, Incorporated, Center for Naval Analyses, Alexandria, VA (Technical Library)
- 1 Jet Propulsion Laboratory, California Institute of Technology, Pasadena, CA (H. Himmelman)
- 1 Lockheed Missiles and Space Company, Incorporated, Sunnyvale, CA via NAVPRO (W. Hendrick)
- 4 McDonnell Douglas Corporation, St. Louis, MO
 - J. L. Gabeer (1)
 - D. Powers (1)
 - E. White (1)
- Technical Library (1)
- 1 Rockwell International Corporation, Downey, CA (H. K. Pratt)
- 2 Sandia Corporation, Livermore, CA (Technical Library)
- 1 Texas Instruments, Incorporated (Missile and Ordnance Division), Dallas, TX

24. Powers, D.R., "Simulation Of Pyrotechnic Shock In A Test Laboratory", Proceedings, Institute of Environmental Sciences, pp. 5-9, April 1976. UNCLASSIFIED.
25. Powers, D.R., "Strain Histories Associated With Stage Separation Systems Using Linear Shaped Charge", Shock and Vibration Bulletin No. 53, Part 1, pp. 89-96, May 1983. UNCLASSIFIED.
26. Powers, D.R., Wright, C.E., and Jones, W.N., "Harpoon Pyrotechnic Shock Study" TP-6133, Naval Weapons Center, China Lake, CA, September 1979. UNCLASSIFIED.
27. Powers, D.R., "Pyroshock Test Simulation Methods", Proceedings, Institute of Environmental Sciences, Pyrotechnic Shock Tutorial Session, 1985. UNCLASSIFIED.
28. Powers, D.R., "Summary Of Testing Techniques", Shock and Vibration Bulletin 56, Part 3, pp. 135-142, August 1986. UNCLASSIFIED.
29. Veit, B.R., "Accelerometer and Shock Amplifier Evaluation Test Report", (to be published as Reg Memo to H.R. Blecha), Naval Weapons Center, China Lake, CA, 1987. UNCLASSIFIED.

8. Bendat, J.S., and Piersol, A.G., *Engineering Applications Of Correlation and Spectral Analysis*, pp.13-15, Wiley, New York, 1980.
9. Powers, D.R., "Charge Amplifier Characteristics When Subjected To Pyrotechnic Shock", Report No. TM-TMHK-ENV-R7484, McDonnell Douglas Astronautics Company, Huntington Beach, CA, 14 January 1987. UNCLASSIFIED.
10. Wilson, J.S., "Accelerometers For Pyroshock Measurements", Proceedings, Institute of Environmental Sciences, pp. 263-267, 1986. UNCLASSIFIED.
11. Sill, R.D., and Leonhardt, P.M., "Instrumentation For Measuring Pyroshock", Proceedings, Institute of Environmental Sciences, Pyrotechnic Shock Tutorial Session, 1985. UNCLASSIFIED.
12. Powers, D.R., "Development Of A Pyrotechnic Shock Test Facility", Shock And Vibration Bulletin No. 44, Part 3, pp. 73-82, 1974. UNCLASSIFIED.
13. Broch, J.T., *Mechanical Vibration And Shock Measurements*, 2nd edition, Bruel & Kjaer, Naerum, Denmark, 1980.
14. Beauchamp, K.G., and Yuen, C.K., *Data Acquisition For Signal Analysis*, George Allen & Unwin, London, 1980.
15. Curtis, A.J., "Shock Data Acquisition And Analysis In The Laboratory", Proceedings, Institute of Environmental Sciences, Pyrotechnic Shock Tutorial Session, 1985. UNCLASSIFIED.
16. Rubin, S., "Concepts In Shock Data Analysis", Chapter 23, *Shock And Vibration Handbook*, 2nd edition, McGraw-Hill, New York, 1976.
17. Kelly, R.D., and Richman, G., *Principles And Techniques Of Shock Data Analysis*, SVM-5, Shock and Vibration Information Center, NRL, Washington, D.C., 1969.
18. Jacobsen, L.S., and Ayre, R.S., *Engineering Vibrations*, McGraw-Hill, New York, 1958.
19. Piersol, A.G., "Evaluation Of The Harpoon Missile Shock Environment During Ejection Launch By Aircraft Launchers", TP-5880, Naval Weapons Center, China Lake, CA, January 1977. UNCLASSIFIED.
20. anon, "Submunition Land-Attack Tomahawk Test Report For Shock Reduction Test Program", Report No. SDP-2401, GDC-AUR-87-135, General Dynamics Convair Division, San Diego, CA, January 1988. UNCLASSIFIED.
21. Bereit, N., et al, "Data Reduction Procedure And Problem Resolution For The U/RGM-109D Payload Cover Separation Tests", Memorandum No. D-87-067-CM, General Dynamics Convair Division, San Diego, CA, 10 November 1987. UNCLASSIFIED.
22. Makarsky, J.A., "BGM-109D Cruise Missile Guidance Set Pyrotechnic Shock Qualification Test Report", Report No. TMHK-26782, McDonnell Douglas Astronautics Company, St. Louis, MO, 25 October 1987. UNCLASSIFIED.
23. Piersol, A.G., "Review of Planned Shock Margin Tests For U/RGM-109D CMGS", Report No. 7117-01, Astron Research and Engineering, Santa Monica, CA, March 1987. UNCLASSIFIED.

Background Noise. Due to the low sensitivity of some of the shock accelerometers used for the U/RGM-109D pyroshock measurements, and other factors limiting the dynamic range of the measurements (see Background section), the pyroshock acceleration data records often include substantial background noise. The effects of this noise on the SRS analysis can be suppressed somewhat by a judicious selection of the record length, as detailed earlier. However, the noise superimposed on the transient signal may still influence the SRS calculation, particularly at the lower frequencies where the actual shock signal is not very intense.

It has been agreed that all U/RGM-109D pyroshock test data should be checked for the possible influence of background noise by calculating a "noise" SRS from a segment of each measured acceleration record preceding the transient. The length of the data segment used to calculate the noise SRS should be identical to the record length used to calculate the actual pyroshock SRS. If there appears to be a change in the background noise on the record from before to after the transient, the procedure should be repeated for a segment of the data record after the transient as well. For the more intense shock measurements, the noise SRS will often approach the pyroshock SRS at the lower frequencies and, hence, limit the accuracy of the low frequency SRS values.

SRS Frequency Range. If the acceleration time history records pass all the editing checks reviewed earlier, there is no reason to question the validity of the resulting SRS calculations at the higher frequencies (2 to 10 kHz). However, it has been agreed that the lower frequency limit for valid data should be established on a case by case basis using the following criteria.

1. The SRS results should be considered invalid at frequencies below that frequency where the noise SRS is less than 6 dB below the pyroshock SRS.
2. A slope in the SRS values of 6 dB/octave below 100 Hz is indicative of good data.
3. In any case, SRS values should not be displayed at frequencies below 100 Hz.

REFERENCES

1. McKinnis, C., and Markle, B., "U/RGM-109D Payload Cover Separation Test Summary and Data Directory", Memorandum No. D-87-065-CM, General Dynamics Convair Division, San Diego, CA, 30 October 1987. UNCLASSIFIED.
2. Kalbfleisch, K.C., "Review Of Pyro-Shock Generating Devices And Source Levels", Proceedings, Institute of Environmental Sciences, Pyrotechnic Shock Tutorial Session, 1985. UNCLASSIFIED.
3. Walton, W.S., "Shock Measurement During Ballistic Impact Into Armored Vehicles", Shock and Vibration Bulletin No. 50, Part 2, pp. 45-55, 1980. UNCLASSIFIED.
4. Galef, A.E., "The Pre-Pulse In Pyroshock Measurement And Analysis", Shock and Vibration Bulletin No. 56, Part 3, pp. 29-32, 1986. UNCLASSIFIED.
5. Cremer, L., Heckl, M., and Ungar, E.E., *Structure-Borne Sound*, Springer-Verlag, New York, 1973.
6. Dranetz, A.I., and Orlicchio, A.W., "Piezoelectric And Piezoresistive Pickups", Chapter 16, *Shock And Vibration Handbook*, 2nd edition, McGraw-Hill, New York, 1976.
7. Bendat, J.S., and Piersol, A.G., *RANDOM DATA: Analysis And Measurement Procedures*, 2nd edition, Wiley, New York, 1986.

1. The data prior to the initiation of the acceleration response should be deleted (the sample record for analysis should start at the exact beginning of the acceleration transient).
2. The data after the acceleration transient has clearly diminished into the instrumentation noise floor should also be deleted.

The latter recommended action requires judgment that should always be conservative; i.e., it is better to make the record too long than too short, since an excessive truncation of the acceleration signal may distort the analysis results more severely than additional noise.

Data Editing. All digitized pyroshock data records should be carefully inspected for errors prior to data reduction by an *experienced* analyst. This should include a visual inspection for the following common anomalies:

1. Obvious wild points, dropouts, magnitude limitations, or other anomalies that are clearly indicative of an ADC malfunction or clipping.
2. Signal terminations indicative of an accelerometer failing or coming off the test structure.
3. Sharp, randomly occurring spikes in the signal indicative of noise due to a loose connector or other intermittent noise sources.
4. Single peaks, zero shifts, or other indications of saturation in the accelerometer, charge amplifier, and/or tape recorder (see [9, 21, 29] for illustrations).

Velocity Validation. Beyond the above visual checks of the data by an experienced analyst, it has been agreed that all U/RGM-109D pyroshock test data should be further checked by an integration to a velocity signal. A clean, accurate pyroshock acceleration signal should integrate to a velocity signal that looks very much like the acceleration signal. If the velocity signal reveals a rapid shift in its mean value, particularly during the early part of the transient where the shock magnitude is intense, this is indicative of a defect in the acceleration measurement. Excellent illustrations are presented in [21]. In applying the velocity data validation procedure, it should be noted that a low frequency trend (usually one or fewer cycles over the record length) can be expected in the integration of any signal, due to the integration of low frequency noise in the data (often called a Wiener process). Care must be exercised to distinguish between the more rapid trends indicative of a spurious acceleration signal, and the slower trends due to a normal integrated noise problem.

DATA ANALYSIS

Type of Analysis. The U/RGM-109D pyroshock data have been, and should continue to be, analyzed in terms of shock response spectra (SRS) with a 5% damping ratio ($Q = 10$). Although the SRS is a controversial data analysis procedure that is vulnerable to misinterpretations, particularly for pyroshock data, it is nevertheless considered to provide the most useful description of shock data from the viewpoint of establishing design criteria and test specifications. Other forms of data analysis, primarily Fourier and energy spectra, have been used very effectively for specialized data studies by GDC [21] and NWC [29], but the SRS with 5% damping is agreed to be the proper U/RGM-109D pyroshock data analysis procedure for general applications.

Initial Conditions. The results of an SRS calculation can be significantly influenced by the initial conditions assumed for the data. It has been agreed that all U/RGM-109D pyroshock data records should be forced to yield a net velocity change of zero from the beginning to the end of the transient event (called the $\Delta V = 0$ criterion) before the SRS calculation is performed. The $\Delta V = 0$ condition is achieved by calculating the average value of the acceleration time history record, and subtracting this average from all data values.

Data Recording. Although online data analysis is desirable to achieve a maximum signal-to-noise ratio (see Background section), the use of tape recorders is necessitated for the U/RGM-109D pyroshock tests performed by GDC and MDAC due to the large number of accelerometer measurements required. To maintain the interchangeability of tape recorders used for the playback of the recorded test data, such data recordings should be made as follows:

1. Only laboratory quality IRIG standard 14-channel FM tape recorders with extended range (Wideband 1) heads should be used.
2. The data recordings should be made with a tape speed of 30 inch/sec, giving a frequency range with Wideband 1 electronics of 0 to 20 kHz.
3. The tape recorders should be calibrated against the NWC Standard Tape.
4. It is acceptable to playback the data recordings at a reduced speed for analog-to-digital conversion and data analysis.

DATA SAMPLING AND EDITING

Digital Sampling Rate. Referring to Figure 8, MDAC uses a digital sampling rate of 65 ksp/s for the U/RGM-109D pyroshock data analysis, which is over six times the highest frequency of interest in the data (about 10 kHz). However, from Figure 7, GDC uses a sampling rate of 40 ksp/s, which is only four times the highest frequency of interest. Although a 4:1 sampling rate is more than adequate for the analysis of stationary data [7, p.339], a higher sampling rate (at least 5:1 and preferably 10:1) is usually desired for pyroshock data [15], particularly when accelerometer resonance problems are anticipated. Nevertheless, the 4:1 rate currently being used by GDC is considered acceptable, as long as it is understood that there may be aliasing problems in the data.

Anti-Aliasing Filters. All measured pyroshock signals should be lowpass filtered for anti-aliasing purposes before digitizing for data analysis. This is true whether or not electronic lowpass filters were used in the charge amplifiers during data acquisition. The anti-aliasing filters should be set with a cut-off frequency equal to the highest frequency of interest in the data, which has been agreed to be 10 kHz for the U/RGM-109D pyroshock data. To avoid filter ringing, the initiation of the filter cut-off should be gradual. The constant delay filters used by GDC [21] represent a good choice from this viewpoint, although they do not provide as rapid a cut-off as the filters in the MDAC GenRad analyzer.

It should be emphasized that anti-aliasing filters must always be used, even though there may have been previous lowpass filtering of the pyroshock signal by electronic filtering in the charge amplifiers and/or the natural filtering provided by the tape recorder above its upper frequency limit. In spite of all such lowpass filtering, aliasing may still be a problem for pyroshock data due to the possible presence of an intense spectral component above the Nyquist frequency caused by an accelerometer resonance. This is a particularly serious problem for the U/RGM-109D pyroshock data analysis being performed by GDC, because they are digitizing the data with a sampling rate of only 40 ksp/s (a Nyquist folding frequency of 20 kHz), and the Endevco Model 2225M5A accelerometers have a casing resonance at about 37 kHz (see Figure 2). This combination will cause aliasing of the 37 kHz accelerometer resonant response down to 3 kHz, where the actual shock data values are not very strong. This problem is discussed further in [21].

Sample Record Lengths. It is the current policy of both GDC and MDAC to select sample records of the recorded pyroshock measurements that are at least 10 msec long, which is more than adequate to cover the significant pyroshock induced structural responses due to the payload cover ejection event. To suppress noise problems in the later analysis, however, it has been agreed that the records should be further limited as follows:

1. The accelerometers must be mounted to the test structure through electrically isolated studs, or with a glue that provides adequate electrical insulation.
2. All accelerometers must be checked with an ohmmeter for possible grounding to the test structure before each test (the only ground should be at the charge amplifier).
3. All wiring between the accelerometers and their charge amplifiers must be noise-treated coaxial cable (no twisted pairs).

Both GDC and MDAC checked for possible EMR contamination of accelerometer signals during early pyroshock tests by hanging an extra accelerometer near the test structure, and wiring it to a charge amplifier exactly like the measurement accelerometers. A significant output from the free accelerometer due to the pyroshock event would have indicated an EMR noise interference problem.

Accelerometer Mountings. Where mounting blocks are needed to attach the accelerometers to the test structure, the following actions are recommended to avoid mounting block resonance and separation problems.

1. The mounting blocks should be aluminum with no dimension greater than 1 inch on a side. This will assure a resonance frequency of the mounting block, loaded with the accelerometer, in excess of 40 kHz.
2. The mounting blocks should be both glued and bolted to the test structure to reduce the risk of separation during the pyroshock.
3. Following each test, the bolts holding the mounting blocks to the test structure should be loosened to determine if the block is still bonded to the structure by the glue. A broken glue bond would indicate the mounting block separated during the pyroshock.

SIGNAL CONDITIONING AND RECORDING

Charge Amplifiers. Both GDC and MDAC generally use either the Endevco MAC system or Endevco Model 2740B charge amplifiers for acquisition of the more intense pyroshock signals, and the Unholtz-Dickie Model UD-22 charge amplifiers for the lower level pyroshock signals. A continuation of this practice is recommended, since the results of experimental studies by NWC [29] as well as MDAC experience indicate the Endevco charge amplifiers may produce slightly better results for intense shock signals.

Electronic Lowpass Filters. It has been concluded from the results in [9, 29] that electronic lowpass filtering in the charge amplifiers with a cut-off frequency of less than 20 kHz should not be used. Even though a 2 kHz lowpass filter would allow SRS calculations with greatly enhanced signal-to-noise ratios, there is strong evidence that such filtering will produce inconsistent SRS results, at least for the more intense pyroshocks.

Mechanical Lowpass Filters. The use of mechanical lowpass filters is not recommended at this time, since no mechanical filter has yet been verified to be effective for the pyroshock signals and accelerometers currently being used for the U/RGM-109D measurements.

Electronic Highpass Filters. There is no objection to electronic highpass filtering in the charge amplifiers with a cut-off frequency of 20 Hz or less, since there is no evidence that such high pass filtering causes erroneous data.

Exact specifications for the Ampex FR-3010 tape recorder and further information on the Standard Tape are available from the Naval Weapons Center, Code 3665, China Lake, CA.

RECOMMENDED PROCEDURES

The pyroshock data from the various tests and experiments summarized in the previous section have been presented during a series of U/RGM-109D Technical Interchange Meetings (TIM's) held primarily at GDC in San Diego, CA (occasional TIM's have been held at GDC in Washington, D.C., MDAC in San Diego, CA, or NTS in Saugus, CA). During TIM No. 9 held on 9 July 1987, an action item was generated to form a "Shock Analysis Working Group" (SAWG) composed of appropriate personnel from NWC, GDC, MDAC, Litton, the Applied Physics Laboratory (APL), and Astron Research and Engineering (Astron). The originally stated purpose of the SAWG was to (a) make a determination of the validity of the U/RGM-109D pyroshock test data produced by the GDC backyard tests, and (b) arrive at a validated SRS that could be used to derive a shock specification for the CMGS. The SAWG was formed and held its first meeting on 9 July 1987, under the chairmanship of G.C. McKinnis of GDC. Three additional meetings of the SAWG were held on 20 July, 5 August, and 10 September 1987, at either GDC or MDAC, San Diego, CA. Beyond the original objectives of the SAWG, the meetings produced a series of agreements on how the pyroshock data associated with the U/RGM-109D program should be acquired, analyzed, and presented. An excellent summary of many of the conclusions of the SAWG are documented by GDC and MDAC in [21]. Based upon the results of the SAWG meetings, and other evaluations by NWC, the more important conclusions concerning the U/RGM-109D shock data, and the basic reasons behind them, are now summarized. It should be understood that the SAWG is still functioning and, hence, additional or modified conclusions and agreements may be forthcoming in the future.

TRANSDUCERS

Accelerometer Types. It was concluded at an early TIM that the principal participants in the U/RGM-109D program should make all pyroshock measurements using similar accelerometers from one test to another, as follows:

1. Endevco Model 2225M5A should be used for the highest level shock measurements (on the Station 18.35 bulkhead).
2. Endevco Model 2225 accelerometers should be used for the intermediate level shock measurements (on the base of CMGS components).
3. Endevco Model 2220 accelerometers should be used for the lowest level shock measurements (on elements inside CMGS components).

It should be emphasized that the reason for this conclusion is not based upon a consensus that these accelerometers are the best available for pyroshock measurements. They were simply the accelerometers first used to acquire U/RGM-109D pyroshock data. It follows that their continued use is desirable to suppress possible data variations due to artifacts of the accelerometer performance and, thus, enhance the comparability of data from one test to another, as well as between GDC and MDAC tests. It should be mentioned that Litton did not use these specific accelerometers for their flat plate pyroshock tests at NTS.

Electrical Isolation. The accelerometers being used for the U/RGM-109D pyroshock measurements are older models that are not electrically insulated. Hence, great care must be exercised to avoid noise problems due to ground loops and the electromagnetic radiation (EMR) pulse generated by the FLSC ignition. Recommended actions include the following:

NWC STANDARD TAPE

Following some of the pyroshock tests performed by the participants in the U/RGM-109D payload cover ejection studies, problems occurred when the data recorded on one tape recorder were played back on a different tape recorder with similar specifications. These problems motivated NWC, Code 3665, to create a "Standard Tape". Copies of this Standard Tape have been provided to the primary U/RGM-109D contractors.

The NWC Standard Tape is not a NBS quality tape; such tapes are usually made on special machines with heads that record across the full width of the tape. The NWC tape was made on a conventional Ampex FR-3010 tape recorder running under tachometer control after being adjusted by factory technicians to be as perfect as feasible. When used properly, the Standard Tape provides a direct way of adjusting the azimuth, speed, and tracking of other tape recorders. The use of the Standard Tape by the different facilities analyzing U/RGM-109D should eliminate potential recorder induced data quality problems, and insure that a tape recording made at one facility will be playable at all other facilities. Of course, the IRIG standards are supposed to insure this, but a recorder adjusted at one edge of the IRIG standard may not be able to play tapes made on another recorder adjusted at the opposite edge of the standard.

The NWC Standard Tape is a mime of the classical azimuth and speed tape, where a 10% of band edge (wideband 2) signal was recorded simultaneously on all tracks. The recording was made such that the third harmonic was 40 dB down from the fundamental, and the recorder was adjusted in the standard manner such that a 1 volt rms input gives a 1 volt rms output. The tape is an original that could be used as a "set level" tape, but the real purpose of the tape is to verify the speed, azimuth, and tracking performance of other tape recorders.

To use the Standard Tape to verify another tape recorder, the following tests are recommended.

Azimuth. NWC measured the variance between the even and odd heads on the Ampex tape recorder to be 2.5 microsec, which means that a 1.5 inch adjustment is accurate to .000125 inch. When the azimuth is aligned such that the delay is constant between the even and odd reproduce heads, and there is no variance across a given reproduce head, the reproduce heads on the recorder being checked are parallel to the record heads on the NWC recorder. A relative measure of how close the record heads are to the NWC recorder can then be made simply by recording a similar signal on a scratch tape, and measuring how much variance there is across the reproduce heads. If NWC made a dub of a test tape, the azimuth error would be at its minimum if the azimuth on the playback recorder is adjusted with the Standard Tape in the above manner.

Speed Accuracy. At 120 inch/sec, the recorded signal should be 50 kHz. If the playback recorder varies by more than ± 200 Hz ($\pm 0.4\%$) from this frequency, the speed probably requires an adjustment.

Tracking. The Ampex technicians measured the physical placement of the tracks on the Standard Tape by recording a short burst of data, cutting off a piece of tape, and developing the tape with an iron based solution so that the magnetized portion of the tape was visible. The sample was examined by an NWC technician with a jeweler's loupe equipped with a calibrated scale. It was confirmed that the tracks were exactly where they should be. A similar experiment can be done by any contractor if an azimuth adjustment yields marginal improvement of a tape recorded on another machine. A check can be made with the Standard Tape, as follows. If the azimuth cannot be adjusted (an intermediate band tape machine has no azimuth adjustment), or the tape will not play back easily, a tracking problem may exist. If the NWC Standard Tape plays well on a playback recorder after the azimuth is adjusted, but when a recording is made, the tape reproduces poorly, then a tracking or record head alignment problem could be indicated.

By using the very high sampling rates, the NWC experiments produced some revealing data. In particular, the measurements provided a clear indication of the theoretical "pre-shock" caused by the near instantaneous velocity change induced by pyroshock events [4]. This is illustrated in Figure 10, which shows the first 0.45 msec of a typical time history measured by an Endevco Model 2255B accelerometer located 2 inches from a 2.5 grain/ft pyroshock source. The data were sampled at a rate of 4000 kps, providing an upper frequency limit of 2000 kHz. Note that there is an initial acceleration pulse with an indicated magnitude of about 80,000 g for this relatively modest pyrotechnic event.

Other significant results of the NWC pyroshock experiments performed to date are as follows:

1. The Endevco Model 2225M5A accelerometer commonly revealed a resonant response at both a casing resonance frequency of about 35-40 kHz, and a crystal resonance frequency of about 82-94 kHz.
2. The Endevco Model 2255B accelerometer sometimes revealed a resonant response, even though its lowest resonance frequency is near 300 kHz. This supports the conclusion that it is not feasible to build an accelerometer that can measure structural responses near a pyroshock excitation without possible ringing.
3. Both the Endevco and the Unholtz-Dickie charge amplifiers (used with an Endevco Model 2225M5A accelerometer) produced inconsistent and often clearly spurious signals when their electronic lowpass filters were in the circuit. However, the Endevco amplifiers appeared, on balance, to provide slightly more consistent data.

In summary, the results of the NWC experiments to date [29] have tended to confirm the basic results of the earlier MDAC-West experiments [9], namely, piezoelectric accelerometers commonly resonate when making pyroshock measurements near the source, and the electronic lowpass filters used in shock measurement charge amplifiers do not appear to be effective in suppressing this spurious portion of the signal. The reason for this malfunction of the charge amplifier lowpass filters is not understood at this time. However, NWC plans to continue these investigations, as well as to pursue further studies of mechanical lowpass filters, which theoretically should resolve the problem. In the meantime, the results of pyroshock measurements with electronic filters having a lowpass cut-off below about 20 kHz must be considered suspect.

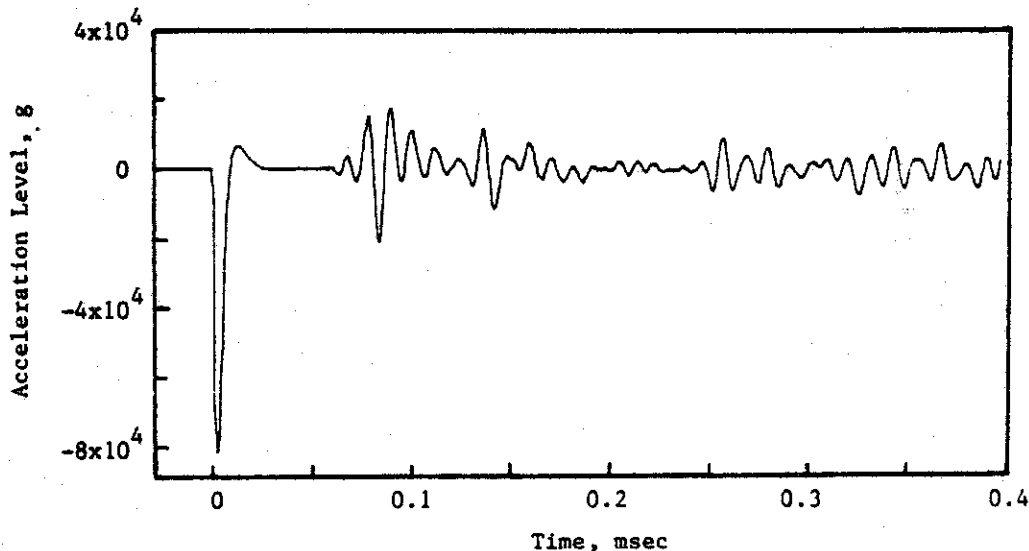

FIGURE 10. Pyroshock Acceleration Time History Showing Pre-Shock Event.

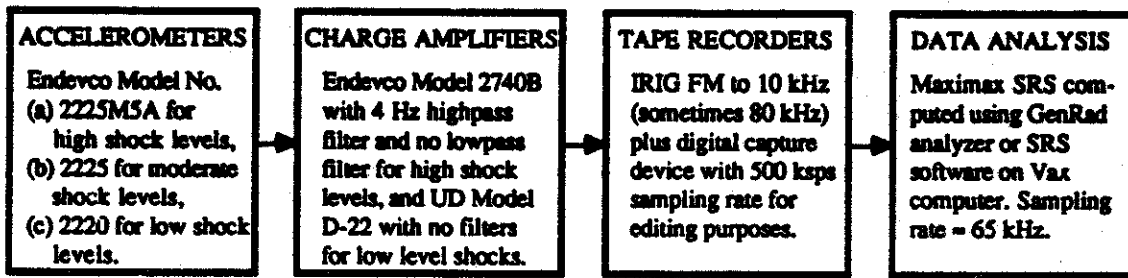

FIGURE 8. Data Acquisition And Analysis System For MDAC CMGS Tests.

LITTON NTS PLATE TESTS

The Litton Industries Guidance and Control Systems Division (Litton), Woodland Hills, CA, which manufactures the RMUC, has been performing extensive tests on RMUC hardware in an effort to identify the mechanism producing the DT-5 flight failure, and to shock qualify future flight hardware. Early shock tests were performed using a conventional drop table in the Litton Woodland Hills facility, but more recent testing has been accomplished using a pyroshock test facility at the National Technical Systems (NTS) laboratory in Saugus, CA. The results of the various Litton drop tests and pyroshock tests of RMUC hardware are being documented, but no formal reports have been issued at this time.

The NTS pyroshock facility used for the Litton RMUC tests consists of a steel plate that is 4 ft long by 5 ft high by 1/4 inch thick, which is supported by steel members that hold the plate at an angle of 22 degrees off vertical. Test items are bolted directly to one side of the plate, and excitation is provided by igniting mild detonation cord placed on the opposite side of the plate. The NTS pyroshock data acquisition and analysis system is outlined in Figure 9.



FIGURE 9. Data Acquisition And Analysis System For NTS RMUC Tests.

NWC PLATE TESTS

In support of the U/RGM-109D pyroshock testing program, the Naval Weapons Center (NWC), China Lake, CA, has been performing pyroshock experiments to evaluate transducers, charge amplifiers, and lowpass filters, including mechanical filters. These tests are being performed on a 24 inch long by 20 inch high by 1/2 inch thick steel plate which is vertically suspended. Various transducers to be evaluated are attached to one side of the plate, and excitation is provided by igniting mild detonation cord attached to the other side of the plate. The experiments are still in progress, but one set of tests has been completed at this time with the results detailed in [29].

The transducers that have been evaluated to date in the NWC tests are the Endevco Models 2225 and 2225M5A, which are used extensively by GDC and MDAC for U/RGM-109D pyroshock measurements, and the more recent Endevco Model 2255B, which employs an integrated charge amplifier and is advertised to have no resonance frequency below 300 kHz. These accelerometers have been tested in conjunction with both the Endevco Model 2740B and the Unholtz-Dickie Model SA-22 charge amplifiers. The data acquisition at NWC is being accomplished using an extended range FM tape recorder good to 80 kHz, and a very high speed ADC that permits accelerometer signals to be sampled at a rate of up to 4000 kbps.

The GDC backyard tests provide the basic description of the dynamic loads due to the U/RGM-109D payload cover ejection event and, hence, the definition of qualification test levels for CMGS components. However, because of the relatively high cost associated with conducting these tests, they have not been used for detailed investigations of the DT-5 flight failure mechanism or the ruggedness of the CMGS components.

MDAC WELDED BODY STRUCTURE TESTS

McDonnell Douglas Astronautics Company (MDAC) in St. Louis, MO, participated in the GDC backyard tests in that most of the pyroshock data collected on the CMGS components during these tests were independently analyzed by MDAC. These data were used by MDAC to produce a qualification test report for the CMGS [22]. Beyond this activity, MDAC has been pursuing CMGS component ruggedness studies using a special test article consisting of a welded body structure, referred to by MDAC as the extended tube forward body section. The original test article simulated the geometry and basic material properties of the U/RGM-109D vehicle, but had no simulation of the engine, wings, payload covers, payload, or accessory equipment, except for the CMGS and the Digital Scene Matching Area Calculator (DSMAC) processor unit. Later in the experimental studies, a missile aft body section (without an engine) and mass simulations of payload bay equipment were added to the welded body structure. The test article also has grooves for the payload cover jettison charges (FLSC) in the missile body structure, rather than in the covers as for the actual vehicle.

The MDAC test article is used to simulate the pyroshock loads on the CMGS components due to the U/RGM-109D payload cover ejection event by igniting a string of mild detonation cord mounted on the outside of the body structure. Payload covers are not jettisoned and no material is cut. Hence, the tests do not provide a fully accurate simulation of the cover ejection event. A considerable effort has been made by MDAC to "tune" the test article so as to generate SRS data in the region of the CMGS that are similar to the SRS results from the GDC backyard tests. Although not in perfect agreement, the SRS data now produced by the MDAC test article are sufficiently similar to the backyard test data to allow the MDAC test article to be used as an effective, low cost test bed for pyroshock studies of the CMGS components. In particular, the MDAC test article has been used extensively to study shock margins and shock induced failures of CMGS components in support of the DT-5 flight failure investigation. These studies are ongoing, and the results at this time have not been published.

The data acquisition and analysis system used for the MDAC test article experiments is outlined in Figure 8. Note that the system is similar to that used for the backyard tests in Figure 7, in particular, the same types of accelerometers are employed. Due to the basic problems associated with accelerometer measurements of pyroshocks discussed in the Background section, it was determined early in the program that comparisons of data from different experiments would be greatly facilitated by using the same types of accelerometers. It is also seen in Figure 8 that MDAC does not use lowpass filters in their charge amplifiers as GDC does. MDAC avoids charge amplifier lowpass filters because of the problems revealed by the pyroshock instrumentation studies detailed in [9]. However, MDAC does use anti-aliasing filters prior to digitizing the data for analysis. MDAC has not published a detailed description of their pyroshock instrumentation system, but some additional details are available from [23], which presents an independent evaluation and critique of the system.

Beyond the pyroshock testing activities directly related to the U/RGM-109D payload cover ejection problem, MDAC-West, Huntington Beach, CA, has been performing extensive, published studies of the simulation and measurement of pyroshock events involving FLSC excitations [9, 12, 24-28]. The results of these general studies have clearly impacted decisions concerning testing procedures and instrumentation during the U/RGM-109D related pyroshock tests. Hence, the MDAC-West experience should be considered part of the body of knowledge that influenced the testing by MDAC-St. Louis, and probably the testing by others as well.

Before closing the background discussions of data analysis, it should be mentioned that there are other techniques for analyzing and evaluating transient data, including pyroshock data. The two most common alternatives are the Fourier spectrum [16] and the energy spectrum [7, p.477], which is simply the square of the magnitude of the Fourier spectrum. These two functions provide a description of the transient environment itself, rather than the effect of the environment on a hypothetical component. They also yield rigorous input/output relationships that are not provided by the SRS. Such analysis procedures have been explored for the evaluation of pyrotechnic and ballistic shocks [19], but have been found lacking for these applications in at least two ways. First, Fourier and energy spectra do not define peak accelerations for either the environment or a component subjected to the environment. Hence, they are not directly indicative of the damage potential of the environment. Second, the estimation of both functions for statistical events like pyroshocks involves large random errors that cannot be adequately suppressed with a severe limitation on the spectral resolution of the analysis.

TESTS AND EXPERIMENTAL STUDIES

Following the DT-5 flight failure, various pyroshock tests and experimental studies were initiated and performed by the major participants in the U/RGM-109D program. The detailed results of these tests and experiments have been or will be published by the responsible organizations, and need not be covered here. However, as further background for the recommendations concerning pyroshock measurement procedures, it is desirable to review the purpose of the principal tests and experiments, and the general manner in which they were executed.

GDC BACKYARD TESTS

Although accelerometers have been carried on a few U/RGM-109D flight tests, the data from those flight measurements have not provided a useful description of the pyroshock environment related to the payload cover ejection event due to inadequate signal crest factors, amplifier slew rates, and/or high extraneous noise. However, the General Dynamics Convair (GDC) Division in San Diego, CA, has performed a series of ground tests that simulate the cover ejection event with what is believed to be a high degree of fidelity. These GDC ground tests (referred to as the "backyard" tests) employ an actual and complete U/RGM-109D vehicle. The payload cover ejection event is accurately simulated by cutting structure similar to the production payload covers (identical to the current production covers on recent tests) with FLSC material similar to that used for the flight ejections. The test item is heavily instrumented with accelerometers concentrated on the Station 18.35 bulkhead that supports the CMGS, and on critical components in the CMGS. The general data acquisition and analysis procedures for the backyard tests are outlined in Figure 7. Note that the primary data analysis and presentation are in terms of a maximax SRS, although other forms of data analysis have been performed by GDC for specialized studies. The reports covering the results of the various backyard tests performed to date are listed in [1, 20], and further details on the data analysis procedures are given in [21].

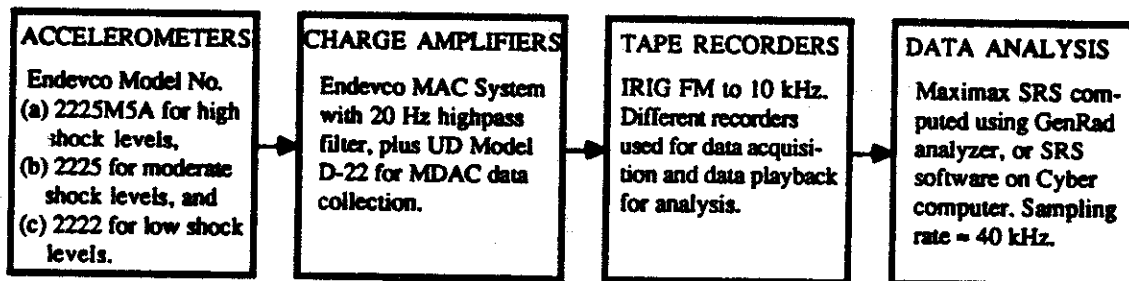

FIGURE 7. Data Acquisition And Analysis System For GDC Backyard Tests.

However, as the number of cycles in the transient increases, the SRS values approach the steady state response of the hypothetical oscillators producing the SRS, given by $Q = 1/(2\zeta)$. This point is illustrated for a sinusoidal transient in Figure 6.

The results in Figure 6 are for zero damping and, hence, the SRS will approach infinity as N becomes large. With nonzero damping, the SRS approaches a limiting value of Q as N becomes large. From Figure 1, it is clear that the large number of oscillations in a typical pyroshock is sufficient to approach this limiting SRS value at the higher frequencies, causing the previously noted sensitivity of pyroshock SRS calculations to the assumed damping value. This also explains why the SRS for a pyroshock usually covers such a wide dynamic range, with a dramatic increase in the SRS values going from low to high frequencies, as illustrated in Figure 5. Even though the energy spectrum for a pyroshock may be nearly uniform with frequency, the SRS values will rise with frequency at a rate asymptotic to 6 dB/octave due to the linear increase in the number of oscillatory cycles of the pyroshock response as a function of frequency.

From the viewpoint of test validation, errors due to the sensitivity of the SRS to the assumed damping can be suppressed by using the same damping for the test simulation analysis as was used to evaluate the actual pyroshock event. However, this approach will be effective only if the test simulation is accomplished using a pyroshock excitation. For example, the SRS for any given pyroshock could be reproduced (with sufficient effort) by a single cycle transient having an appropriate wave form. However, the required peak acceleration of that single cycle transient would be very much larger than the actual peak acceleration of the pyroshock, raising serious questions about the accuracy of the test simulation from a damage potential viewpoint.

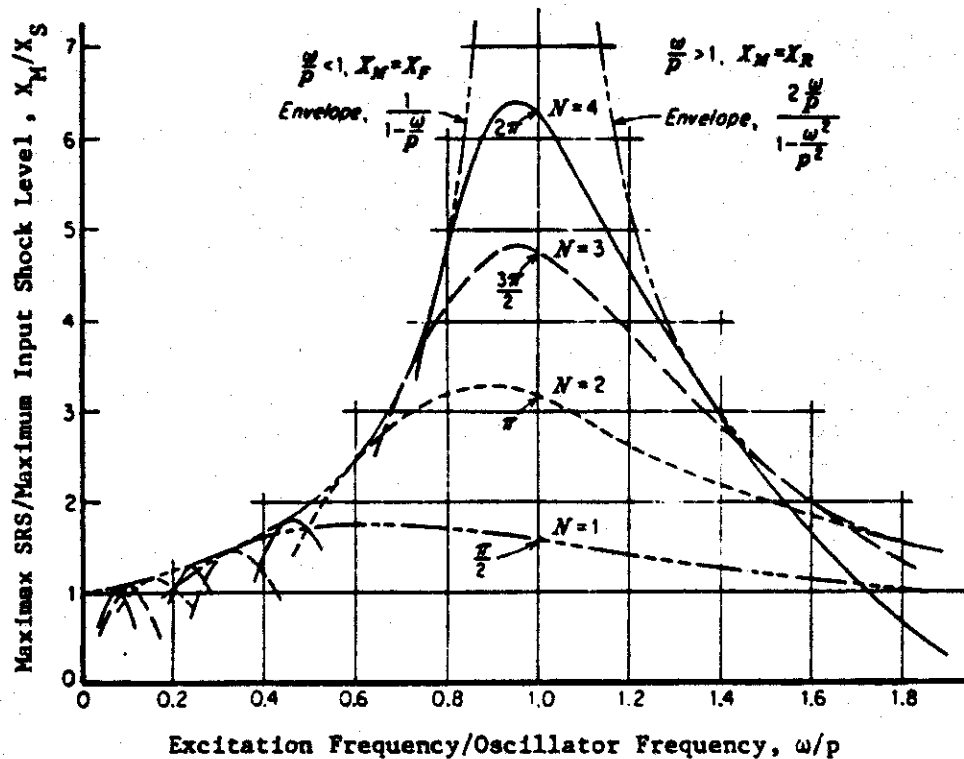

FIGURE 6. Maximax SRS For Sinusoidal Forcing Functions With A Duration Equal To An Integer Number Of Half Cycles [18].

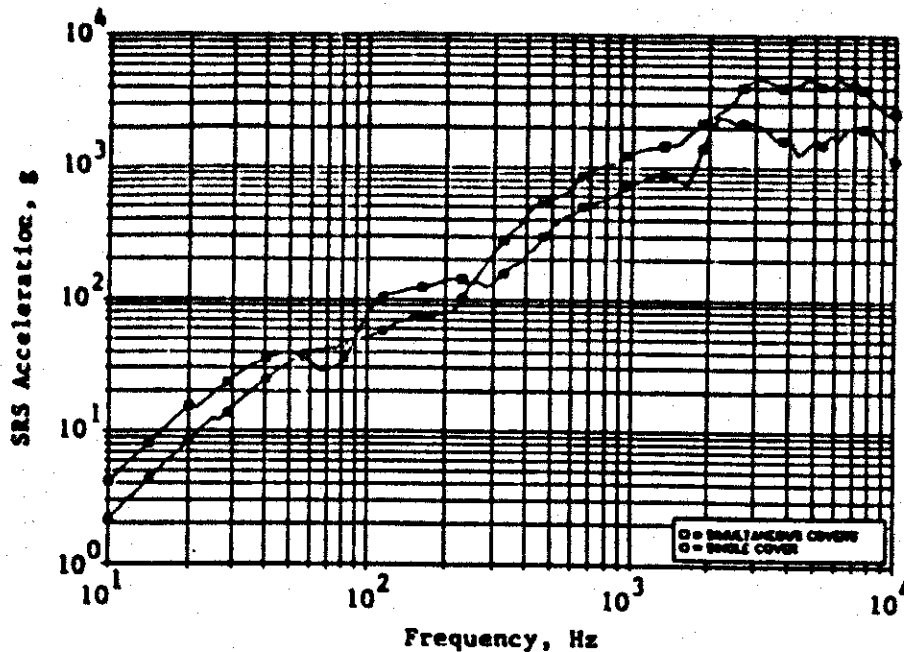

FIGURE 5. Maximax SRS For U/RGM-109D Payload Cover Ejection Event [21].

The theory behind the use of the SRS for shock data analysis is as follows. If a mechanical component of interest were subjected to the measured shock, the component would respond at all its resonance frequencies that fall in the frequency range of the shock. If it is assumed that each component resonance produces a linear response with a damping value equal to the damping used to define the SRS, then the measured SRS identifies the maximum (peak) acceleration response of that component at each of its resonance frequencies due to an exposure to that shock. The actual frequencies of the component resonances do not have to be known, since the SRS yields the maximum acceleration response for any resonance frequency that might exist within the frequency range of the analysis. This interpretation makes the SRS a very useful tool for design purposes, as well as for assessing the equivalence of simulated shocks relative to actual shock environments for testing purposes.

The concept and application of the SRS is controversial for a number of reasons, including the following:

1. The SRS for a given shock is not unique; i.e., there are numerous different transient time histories that will produce the same SRS.
2. The SRS does not account for the peak acceleration, and hence the damage potential, due to the multi-mode response of a component.
3. The linearity assumption in the SRS is sometimes questionable, particularly for components subjected to high intensity, multi-cycle transients like pyroshocks.
4. The SRS is highly sensitive to errors in the assumed damping value for multi-cycle transients like pyroshocks.

The last problem is the most serious from the viewpoint of pyroshock simulations for testing purposes. Specifically, the values of the SRS for a single cycle transient (a pulse) can never exceed twice the peak acceleration of the transient, no matter what damping value is assumed [18].

DATA ANALYSIS

The analysis of pyroshock data is usually accomplished by the calculation of a shock response spectrum (SRS) [15-18]. Shock response spectra can be defined for any response parameter of interest, but absolute acceleration is the most commonly used response parameter for calculating the SRS of aerospace vehicle pyroshock measurements. The acceleration SRS is defined as the maximum acceleration response of a simple mechanical oscillator (single degree-of-freedom system) to the measured acceleration time history of the shock, as a function of the resonance frequency of the oscillator. The mechanical analog of the SRS calculation is illustrated in Figure 4.

There are several SRS values that might be of interest for different applications, namely, the maximum acceleration responses of the oscillators that occur

- (a) during the application of the shock (primary SRS),
- (b) after the shock is over (residual SRS),
- (c) in the positive direction (positive SRS),
- (d) in the negative direction (negative SRS), and
- (e) at any time in either direction (maximax SRS).

Each of the noted SRS functions must also be identified with a specific value of damping for the oscillators (usually defined in terms of a damping ratio, ζ , or a "quality factor", $Q = 1/(2\zeta)$). Commonly assumed values of damping for SRS calculations range from zero to 5% of critical. The maximax SRS with a damping ratio of 5% ($\zeta = 0.05$) is the quantity used for the U/RGM-109D pyroshock studies. A typical SRS computed on the Station 18.35 bulkhead during a U/RGM-109D payload cover ejection is shown in Figure 5.

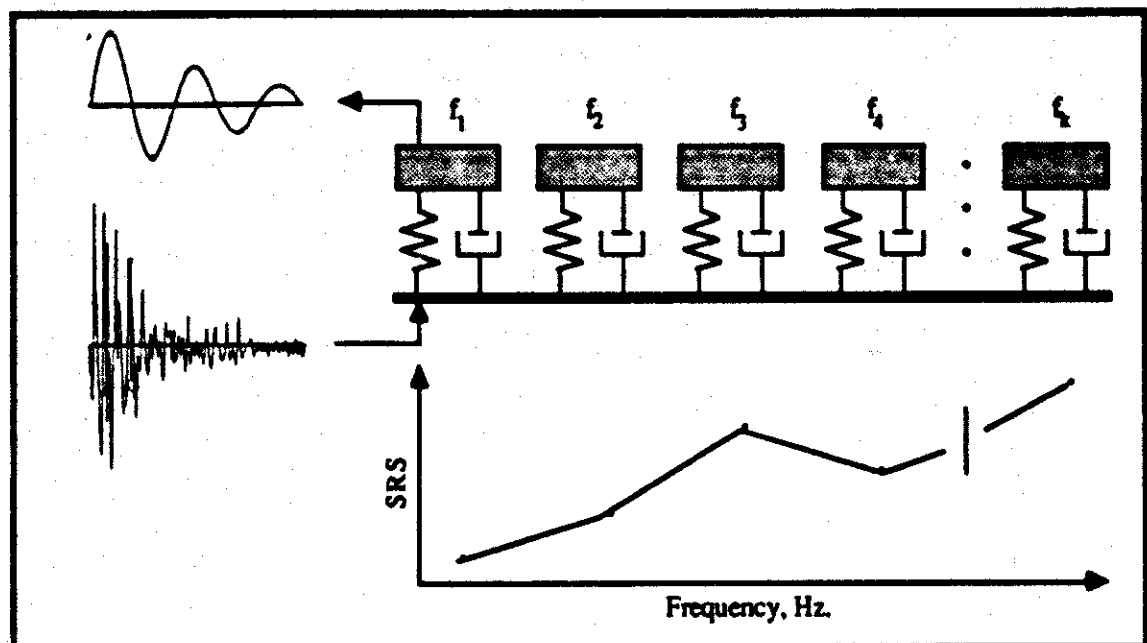

FIGURE 4. Illustration Of Shock Response Spectrum Measurement.

during a pyroshock event, it is often necessary to set the recorder input gain to a conservative value to assure against an overload. This means that the useful dynamic range of the recorded data may be very much less than 48 dB, perhaps only 30 to 40 dB. For those pyroshock measurements that include any significant "ringing" of the accelerometer, this dynamic range limitation will often cause the actual signal of interest to be buried in the tape recorder noise.

There is very little that can be done about the inherent dynamic range limitations of FM tape recorders, other than to bypass the recorder and go directly to a digital storage device. The analog-to-digital converters (ADC's) for modern digital storage instruments usually employ at least 12 bit codes (sometimes 16 bits). The theoretical dynamic range (in terms of the peak signal to rms noise ratio) is 83 dB for a 12 bit converter and 107 dB for a 16 bit converter [7, p.340]. Hence, even allowing for a conservative gain setting to prevent a possible overload, digital capture devices will generally allow an adequate dynamic range for pyroshock signals.

ANTI-ALIASING FILTERS

When digital capture and data storage devices are used, care must be exercised to avoid the serious problems that can arise due to a phenomenon called aliasing [7, p.337]. Specifically, the time history data must be sampled at a rate that is twice as high as the highest frequency present in the data; i.e., the highest frequency that can be defined in a digital time series is $f_c = 1/(2\Delta t) = \text{sps}/2$, where Δt is the sampling interval in sec and $\text{sps} = 1/\Delta t$ is the sampling rate in samples per sec. Any data at frequencies above f_c (called the Nyquist frequency) will fold back and appear in the digital data at frequencies below f_c . For any frequency f in the range $0 \leq f \leq f_c$, the higher frequencies in the original data that will be aliased with f are defined relative to f_c by $(2f_c \pm f), (4f_c \pm f), \dots, (2nf_c \pm f); n = 1, 2, 3, \dots$

Aliasing errors can be particularly severe for pyroshock data because of the possible "ringing" of the accelerometer at frequencies above the Nyquist frequency. For example, consider the acceleration time history in Figure 2, where there is a dominant component at about 37 kHz due to an accelerometer resonance. If these data had been acquired with a digital sampling rate of, say, 40 ksp/s, making $f_c = 20$ kHz, the 37 kHz component would have been aliased down to appear in all data analysis at 3 kHz. The potential for serious misinterpretations of digitally acquired pyroshock data due to aliasing is clear.

* Since pyroshock data typically extend to very high frequencies, the only way to avoid aliasing is to insert lowpass analog filters (called anti-aliasing filters) before the ADC. Due to the general filtering problems discussed earlier, anti-aliasing filters for pyroshock measurements are designed with a relatively slow roll-off. Hence, it is common to set the filter cut-off frequency to be no more than 50% of the Nyquist frequency (sps/4). Even then, significant aliasing might still occur if the Fourier spectrum of the pyroshock signal increases with frequency at a rate approaching the cut-off rate of the anti-aliasing filter. As mentioned earlier, possible ringing of the accelerometer due to a sensing element or casing resonance constitutes a particularly serious problem, since the spectral peak caused by the ringing may leak through the anti-aliasing filter at a higher level than the actual data below the Nyquist frequency. Of course, increasing the ADC sampling rate to move the Nyquist frequency above the frequencies of possible accelerometer resonances would eliminate this problem. Nevertheless, even if an ADC sampling rate of, say, 1000 ksp/s is used, anti-aliasing filters are still needed, since significant acceleration responses in excess of 500 kHz have been identified in pyroshock signals during studies to be discussed later.

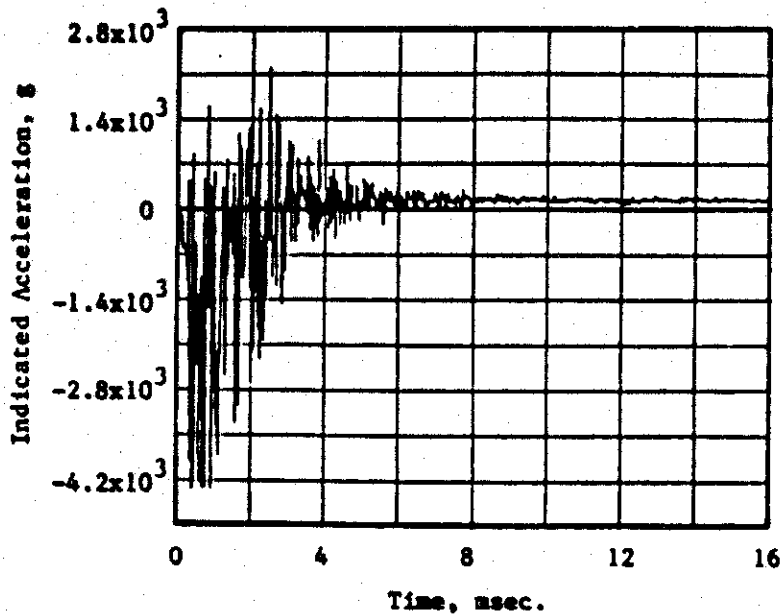

FIGURE 3. Pyroshock Acceleration Time History With Typical Zero Offset Due To Accelerometer And/Or Amplifier Saturation [21].

MECHANICAL LOWPASS FILTERS

The obvious solution to the problem of accelerometer "ringing" and the resulting amplifier problems in pyroshock measurements is to prevent the high frequency portion of the shock from reaching the accelerometer and exciting its resonance frequencies. This can be accomplished by inserting a mechanical lowpass filter between the accelerometer and the measurement location, where the upper cut-off frequency of the mechanical filter is well below the lowest resonance frequency of the accelerometer. Such mechanical filters have been available commercially for many years [13, p.126]. However, the filters must be "tuned" for specific accelerometers and used within a narrow temperature range to be effective. Even then, they may "bottom" when subjected to an intense pyroshock, and often have poor transverse response characteristics.

Recently, a major producer of piezoelectric accelerometers introduced a new accelerometer that incorporates a mechanical filter in the support of the sensing element. At this time, the new transducer has not been fully evaluated by an independent source. However, if it proves successful, it may lead to a new line of accelerometers that will largely eliminate a major problem in the measurement of intense pyroshocks.

DATA RECORDING AND STORAGE

When feasible, it is desirable to digitally capture and analyze measured pyroshock signals online, directly out of the amplifier. There are many cases, however, where this may not be feasible (or at least not convenient), particularly when a large number of accelerometer measurements are being made simultaneously. Hence, pyroshock data are commonly recorded on analog FM tape recorders for storage and later analysis. Assuming the tape recorder meets IRIG standards, the dynamic range (peak signal-to-noise ratio) for FM recordings is a maximum of 48 dB [7, p.334]. Since there is usually considerable uncertainty about the peak acceleration value that will occur

due to a deformation of the sensing element.

6. Accelerometers that are not electrically isolated may ground and cause severe noise contamination due to ground loops.
7. The accelerometer output may be influenced by the electromagnetic pulse generated by the pyroshock detonating device.

These various problems can be largely suppressed by a proper selection and use of accelerometers for pyroshock applications [10-12] and good measurement procedures, which are discussed later.

ACCELEROMETER AMPLIFIERS AND LOWPASS FILTERS

Both piezoelectric and piezoresistive transducers must be used with a supporting amplifier or power supply. Since piezoelectric accelerometers are being used for essentially all the pyroshock measurements on the U/RGM-109D program, attention will be limited to the amplifiers appropriate for this type of accelerometer.

Piezoelectric accelerometers are essentially charge generating devices with a very high source impedance. Hence, the transfer of the output signal through cables to analysis equipment is vulnerable to losses due to the cable capacitance, as well as noise contamination. Some manufacturers build piezoelectric accelerometers with integrated electronic circuits that convert the charge signal into a voltage signal with a relatively low source impedance within the accelerometer. However, most of the accelerometers used for the pyroshock measurements on the U/RGM-109D program (at least by GDC and MDAC) are not of this type, meaning the charge signals must be transferred through noise-treated coaxial cables to amplifiers that have a charge converter as their first stage. See [12-14] for more detailed descriptions of these measurement systems.

The amplifiers used with piezoelectric accelerometers often include an electronic lowpass filter with a selectable upper cut-off frequency, ranging from 2 kHz to 20 kHz, immediately before the charge converter. The purpose of this filter is to allow the user to suppress the high frequency content of the measured shock signal before further signal conditioning, voltage amplification, and recording operations are performed. Since the high frequency portion of pyroshock acceleration signals is very intense, and is often (but not always) considered to be unimportant from the viewpoint of damage potential, removing that portion of the signal early in the data acquisition process can greatly enhance the signal-to-noise ratio in later calculations, without the loss of relevant information. In particular, the lowpass filter would appear to provide a solution to the problems posed by the "ringing" of the accelerometer sensing element. Specifically, it would simply filter out all signals due to resonant responses within the accelerometer, as long as they are above the filter cut-off frequency. However, experience suggests the accelerometer "ringing" problem is not so easily resolved. A detailed study of various different piezoelectric accelerometer-amplifier systems in [9] indicates that the lowpass filters in at least some commercial amplifiers appear to malfunction when the upper cut-off frequency is set to 2 kHz. The source of the problem is not fully understood, although it may be related to (a) sufficient leakage through the filter to overload the amplifier, or (b) an inherent inability of the filter to properly operate on very short duration events.

Even when lowpass filters are not used, the amplifier will produce spurious results if saturation due to an overload occurs. The most common symptom of amplifier saturation is a zero offset in the resulting acceleration time history, as illustrated by the saturated measurement shown in Figure 3. Of course, saturation of the piezoelectric crystal in the accelerometer will cause a similar zero offset. Hence, such a result is simply an indication that saturation occurred somewhere in the accelerometer-amplifier system, and the resulting data should be considered spurious.

Unfortunately, due to the near delta function character of pyroshocks, the frequency spectrum of the structural response near such shocks includes energy to extremely high frequencies (the theoretical spectrum for a delta function is uniform over an infinite frequency range [8]). Hence, it is common for pyroshock measurements to be severely distorted by transducer resonances. This is illustrated in Figure 2, which shows the acceleration time history measured by an Endevco Model 2225M5A accelerometer during a pyroshock test performed by MDAC-West [9]. Note that the measured acceleration signal is dominated by a response component with a frequency of about 37 kHz. The Endevco 2225M5A accelerometer is known to have a casing resonance at this frequency. It is clear from Figure 2 that the signal due to the accelerometer resonance is so strong that it obscures the actual structural acceleration data of interest.

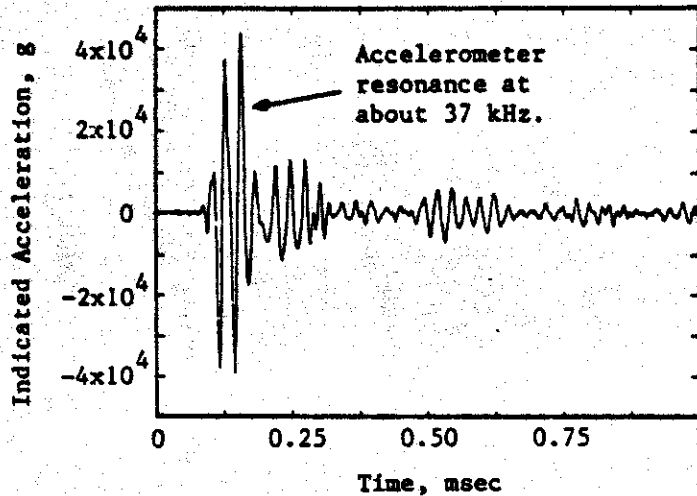

FIGURE 2. Pyroshock Acceleration Time History With High Frequency Component Due To Accelerometer Resonance [9].

The manufacturers of accelerometers produced for shock measurement applications have attempted to circumvent the above noted problem by designing accelerometers with the highest feasible resonance frequency (up to as high as 1000 kHz). However, as will be discussed later, they have failed to date to build an accelerometer that does not produce a resonant response when measurements are made near a pyroshock excitation. Hence, such a resonant response must be assumed to exist in all pyroshock measurements made near the source of excitation, even though the frequency response range of the analysis equipment may not cover a sufficiently high frequency to see that resonant response.

Other potential problems associated with accelerometer measurements of pyroshocks include the following:

1. The accelerometer may physically break.
2. The accelerometer connectors may break, or momentarily open circuit causing severe noise contamination of the signal, particularly with piezoelectric accelerometers.
3. Also for piezoelectric accelerometers, the piezoelectric crystal may saturate, causing a zero shift in the output signal.
4. The accelerometer may loosen or break free from its mounting.

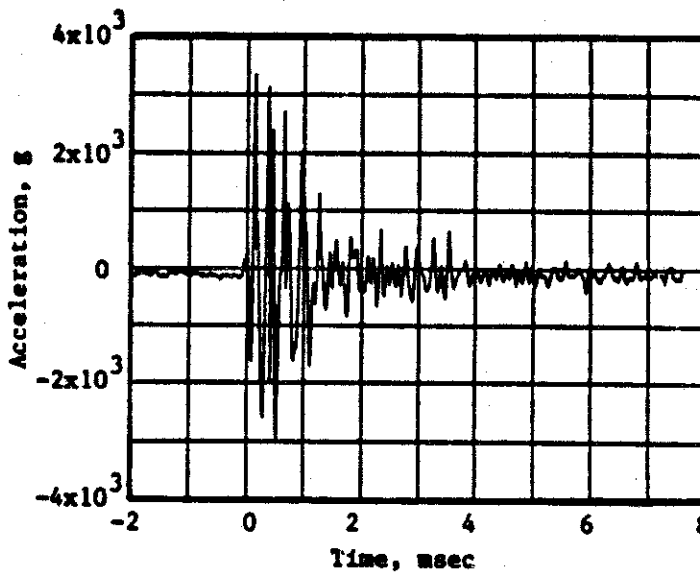

FIGURE 1. Typical Acceleration Time History For A Pyroshock Event.

The basic characteristics of pyroshocks are similar to the ballistic shocks caused by the impact of non-penetrating projectiles on a hard structure [3], in that they produce a near instantaneous velocity change of the structure at the moment of impact. Hence, the acceleration response of the structure near the point of impact approaches a true impulse or delta function; i.e., an acceleration that momentarily approaches an infinite value at the instant of impact [4]. The result is the generation of intense stress waves that propagate throughout the structure, some in a non-dispersive manner at the speed of sound in the material (longitudinal and torsional waves), and others in a dispersive manner at a "group velocity" that is dependent upon the geometry of the structure and frequency (bending waves) [5]. Discontinuities in the structural propagation path (in particular, bolted or riveted joints) will strongly reflect and attenuate bending waves. Also, the dispersive character of bending waves causes them to spread in time with increasing distance from the source, reducing the sharpness of the wave front. On the other hand, longitudinal waves tend to propagate more easily through discontinuities, and with smaller loss factors. In either case, however, when the measurement location is near the pyrotechnic source, as is the case in the U/RGM-109D payload cover ejection problem, the accurate measurement of the structural response to the pyroshock constitutes a major challenge.

MEASUREMENT TRANSDUCERS

Most pyroshock measurements are made using either piezoelectric or piezoresistive (strain gage) type accelerometers. In either case, the accelerometer essentially consists of a lightly damped resonant element that functions theoretically like a seismic accelerometer [6; 7, p.327]; i.e., it translates an acceleration at the base of the transducer into an electrical signal (charge or voltage) that is proportional to acceleration in the frequency range well below the resonance frequency of the sensing element. As long as the structural response being measured has no significant energy in the frequency range near the resonance frequency of the sensing element, the transducer (if properly used) will generally yield an accurate measure of the acceleration time history at its base. However, if there is significant energy in the frequency range of the sensing element resonance, the element will "ring" causing a strong transducer output signal at that resonance frequency, which may be much stronger than the true acceleration signal. The resonance frequencies of other mechanical elements of the transducer, such as the casing, will cause the same effect.

INTRODUCTION

The land attack version of the Tomahawk cruise missile (U/RGM-109D) incorporates a payload bay that extends forward to about missile Station 26, approximately 8 inches aft of a bulkhead at Station 18.35 where the Cruise Missile Guidance Set (CMGS) is mounted. The payload bay covers, one on each side of the vehicle, are severed around their perimeters and jettisoned in flight using a Flexible Linear Shaped Charge (FLSC) that is packed into grooves in the covers. This payload cover ejection event results in a strong pyrotechnic transient (pyroshock) that constitutes a significant dynamic load on the CMGS equipment.

During the second development test flight of the U/RGM-109D missile (Mission D-1:DT-5), the CMGS malfunctioned and the missile crashed shortly after the payload cover ejection event. There is strong evidence that the malfunction was due to a pyroshock induced soft failure of the CMGS, specifically, a memory alteration in the CMGS Reference Measuring Unit and Computer (RMUC) [1]. This malfunction initiated not only a detailed investigation of the specific failure, but also an extensive study of improved procedures for the measurement and interpretation of pyroshock data.

Pyroshock induced structural response data constitute one of the most difficult dynamic phenomenon to measure in practice. In particular, the basic characteristics of pyroshocks impose mechanical requirements that exceed the capabilities of commonly used motion transducers (accelerometers). This fact has led to difficulties in the investigation and solution of the U/RGM-109D payload cover ejection shock problem. Nevertheless, considerable progress has been made in the measurement and interpretation of the pyroshock data collected during the various experiments performed by the major participants in the program, namely, the General Dynamics-Convair (GDC) Division, the McDonnell Douglas Astronautics Company (MDAC), Litton Industries Guidance and Control Systems Division (Litton), and the Naval Weapons Center (NWC), China Lake. The purpose of this document is to clarify the basic problems related to the measurement of pyroshocks, summarize the results of experimental studies of transducers and techniques, and detail recommendations for the appropriate measurement and interpretation of pyroshock data that evolved from these studies.

The report is divided into four sections, including this introductory section. The second section presents background material on the general problems associated with pyroshock measurements, supported by appropriate references. The third section summarizes the various pyroshock tests and experiments performed to date by the primary participants in the study of the U/RGM-109D payload cover ejection problem. The concluding section details specific recommendations concerning pyroshock measurements on the U/RGM-109D program.

BACKGROUND

The term pyroshock (or pyrotechnic shock) generally refers to the severe mechanical transients caused by the detonation of an ordnance device on a structure. Such devices (linear shaped charges, primacord, mild detonation cord, explosive bolts, etc.) are widely used to accomplish the in-flight separation of structural elements on aerospace vehicles [2]. A typical pyroshock acceleration time history record is shown in Figure 1.

FIGURES

1. Typical Acceleration Time History For A Pyroshock Event	2
2. Pyroshock Acceleration Time History With High Frequency Component Due To Accelerometer Resonance	3
3. Pyroshock Acceleration Time History With Typical Zero Offset Due To Accelerometer And/Or Amplifier Saturation	5
4. Illustration Of Shock Response Spectrum Measurement	7
5. Maximax SRS For U/RGM-109D Payload Cover Ejection Event	8
6. Maximax SRS For Sinusoidal Forcing Functions With A Duration Equal To An Integer Number Of Half Cycles	9
7. Data Acquisition And Analysis System For GDC Backyard Tests	10
8. Data Acquisition And Analysis System For MDAC CMGS Tests	12
9. Data Acquisition And Analysis System For NTS RMUC Tests	12
10. Pyroshock Acceleration Time History Showing Pre-Shock Event	13

CONTENTS

Introduction 1

Background 1

 Measurement Transducers 2

 Accelerometer Amplifiers and Lowpass Filters 4

 Mechanical Lowpass Filters 5

 Data Recording and Storage 5

 Anti-Aliasing Filters 6

 Data Analysis 7

Tests And Experimental Studies 10

 GDC Backyard Tests 10

 MDAC Welded Body Structure Tests 11

 Litton NTS Plate Tests 12

 NWC Plate Tests 12

 NWC Standard Tape 14

Recommended Procedures 15

 Transducers 15

 Signal Conditioning And Recording 16

 Data Sampling And Editing 17

 Data Analysis 18

References 19



Accession For	
NTIS GRA&I	<input checked="" type="checkbox"/>
DTIC TAB	<input type="checkbox"/>
Unannounced	<input type="checkbox"/>
Justification	
By _____	
Distribution/	
Availability Codes	
Dist	Avail and/or Special
A-1	

UNCLASSIFIED

SECURITY CLASSIFICATION OF THIS PAGE

REPORT DOCUMENTATION PAGE

1a. REPORT SECURITY CLASSIFICATION Unclassified		1b. RESTRICTIVE MARKINGS			
2a. SECURITY CLASSIFICATION AUTHORITY		3. DISTRIBUTION / AVAILABILITY OF REPORT A Statement.			
2b. DECLASSIFICATION / DOWNGRADING SCHEDULE					
4. PERFORMING ORGANIZATION REPORT NUMBER(S) 7141-01		5. MONITORING ORGANIZATION REPORT NUMBER(S) NWC TP 6927			
6a. NAME OF PERFORMING ORGANIZATION Astron Research and Engineering	6b. OFFICE SYMBOL <i>(if applicable)</i>	7a. NAME OF MONITORING ORGANIZATION Naval Weapons Center			
6c. ADDRESS (City, State, and ZIP Code) Santa Monica, CA 90404		7b. ADDRESS (City, State, and ZIP Code) China Lake, CA 93555-6001			
8a. NAME OF FUNDING / SPONSORING ORGANIZATION Naval Air Systems Command	8b. OFFICE SYMBOL <i>(if applicable)</i>	9. PROCUREMENT INSTRUMENT IDENTIFICATION NUMBER Contract No. N60530-87-D-0089			
8c. ADDRESS (City, State, and ZIP Code) Washington, DC 20630-5460		10. SOURCE OF FUNDING NUMBERS			
		PROGRAM ELEMENT NO.	PROJECT NO.	TASK NO. PMA-2805A-88-01	WORK UNIT ACCESSION NO.
11. TITLE (Include Security Classification) PYROSHOCK DATA ACQUISITION AND ANALYSIS FOR U/RGM-109D PAYLOAD COVER EJECTION TESTS (U)					
12. PERSONAL AUTHOR(S) Piersol, Allan G.					
13a. TYPE OF REPORT Final	13b. TIME COVERED FROM 87 Jan TO 88 Mar	14. DATE OF REPORT (Year, Month, Day) 1988, September	15. PAGE COUNT 21		
16. SUPPLEMENTARY NOTATION					
17. COSATI CODES			18. SUBJECT TERMS (Continue on reverse if necessary and identify by block number)		
FIELD	GROUP	SUB-GROUP	Tomahawk Shock Environments, High Frequency (Pyroshock), Shock Spectrum		
19. ABSTRACT (Continue on reverse if necessary and identify by block number)					
<p>During the second development test flight of the U/RGM-109D Tomahawk cruise missile, a malfunction occurred in the Cruise Missile Guidance Set (CMGS) that is believed to have been initiated by the pyroshock loads resulting from the ejection of the payload bay covers. This malfunction motivated an extensive program of ground tests designed to simulate the pyroshock environment seen by the CMGS due to the payload bay cover ejection event. During the course of these tests, a number of problems were encountered in obtaining reliable measurements and assessments of the pyroshock data. Through a collective action by the major participants in the U/RGM-109D program, many of these problems have now been resolved, and reliable data defining the pyroshock loads on the CMGS and its components due to the payload bay cover ejection event have been established. These data provide a baseline for a definition of a shock specation of CMGS components, as well as for continued experimental studies of the ruggedness of components to pyroshock loads. This report details the fundamental problems associated with the measurement of pyroshock environments using piezoelectric accelerometers, and summarizes the actions taken to suppress these problems in the measurements made during the various U/RGM-109D ground tests simulating the payload bay cover ejection event.</p>					
20. DISTRIBUTION / AVAILABILITY OF ABSTRACT <input checked="" type="checkbox"/> UNCLASSIFIED/UNLIMITED <input type="checkbox"/> SAME AS RPT. <input type="checkbox"/> DTIC USERS			21. ABSTRACT SECURITY CLASSIFICATION Unclassified		
22a. NAME OF RESPONSIBLE INDIVIDUAL W. Ned Jones			22b. TELEPHONE (Include Area Code) 619-939-4659	22c. OFFICE SYMBOL 3665	

Naval Weapons Center

FOREWORD

This is a final report on the U/RGM-109 payload cover ejection pyroshock data acquisition and analysis. The work, authorized by the Naval Air Systems Command and funded by AIRTASK PMA-2805A-88-01 under Contract No. N60530-87-D-0089, was performed from January 1987 to March 1988.

In the interest of economy and timeliness in presenting the information, the report is being published as originally submitted.

This report was reviewed for technical accuracy by Ronald G. Merritt.

Approved by
S. HAALAND, *Head*
Engineering Department
16 September 1988

Under authority by
J. A. BURT
Capt., USN
Commander

Released for publication by
G. R. SCHIEFER
Technical Director

NWC Technical Publication 6927

Published by Technical Information Department
Collation Cover, 13 leaves
First printing 155 copies

DTIC FILE COPY

700841

NWC TP 6927

(2)

AD-A229 632

Pyroshock Data Acquisition and Analysis for U/RGM-109D Payload Cover Ejection Tests

by
Allan G. Pierson
Astron Research and Engineering
for
Engineering Department

SEPTEMBER 1968

NAVAL WEAPONS CENTER
CHINA LAKE, CA 93555-6001



DTIC
ELECT.
DEC 27 1968
S B D
Co

Approved for public release; distribution is unlimited.

90 12 26 051